

SAR MEASUREMENT REPORT

1.1 Scope

Environmental evaluation measurements of specific absorption rate¹ (SAR) distributions in simulated human head and body tissues exposed to radiofrequency (RF) radiation from wireless portable devices for compliance with the rules and regulations of the U.S. Federal Communications Commission (FCC).²

Company Name: CELL SHIELD INC.

- EUT Type: Ceramic composition absorber
- Trade Name / Model: **CELL SHIELD**
- Dates of Tests: November 27, 2000
Place of Tests: PCTEST Engineering Lab.
Columbia, MD, U.S.A.
- Report Serial No.: SAR.201115578.CSI

The Cell Shield Electromagnetic Field Absorber was tested with typical Cellular Phone with the antenna extended and retracted. The Absorber was positioned on the host phone in the locations recommended by CELL SHIELD. The host phone was a dual mode phone with a frequency range of 824.04-848.97 MHz.



NVLAQ[®]
Lab Code 100431-0

¹ Specific Absorption Rate (SAR) is a measure of the rate of energy absorption due to exposure to an RF transmitting source (wireless portable device).

² IEEE/ANSI Std. C95.1-1992 limits are used to determine compliance with FCC ET Docket 93-62.

2.1 INTRODUCTION

The FCC has adopted the guidelines for evaluating the environmental effects of radiofrequency radiation in ET Docket 93-62 on Aug. 6, 1996 to protect the public and workers from the potential hazards of RF emissions due to FCC-regulated portable devices.[1]

The safety limits used for the environmental evaluation measurements are based on the criteria published by the American National Standards Institute (ANSI) for localized specific absorption rate (SAR) in *IEEE/ANSI C95.1-1992 Standard for Safety Levels with Respect to Human Exposure to Radio Frequency Electromagnetic Fields, 3 kHz to 300 GHz*. (c) 1992 by the Institute of Electrical and Electronics Engineers, Inc., New York, New York 10017.[2] The measurement procedure described in *IEEE/ANSI C95.3-1992 Recommended Practice for the Measurement of Potentially Hazardous Electromagnetic Fields - RF and Microwave*[3] is used for guidance in measuring SAR due to the RF radiation exposure from the Equipment Under Test (EUT). These criteria for SAR evaluation are similar to those recommended by the National Council on Radiation Protection and Measurements (NCRP) in *Biological Effects and Exposure Criteria for Radiofrequency Electromagnetic Fields*, NCRP Report No. 86 (c) NCRP, 1986, Bethesda, MD 20814.[4] SAR is a measure of the rate of energy absorption due to exposure to an RF transmitting source. SAR values have been related to threshold levels for potential biological hazards.

2.2 SAR Definition

Specific Absorption Rate (SAR) is defined as the time derivative (rate) of the incremental energy (dU) absorbed by (dissipated in) an incremental mass (dm) contained in a volume element (dV) of a given density (ρ). It is also defined as the rate of RF energy absorption per unit mass at a point in an absorbing body (see Fig. 2).

$$SAR = \frac{d}{dt} \left(\frac{dU}{dm} \right) = \frac{d}{dt} \left(\frac{dU}{\rho dV} \right)$$

Figure 2. SAR Mathematical Equation

SAR is expressed in units of Watts per Kilogram (W/kg).

$$SAR = \sigma E^2 / \rho$$

where:

| | | |
|----------|---|---|
| σ | = | conductivity of the tissue-simulant material (S/m) |
| ρ | = | mass density of the tissue-simulant material (kg/m ³) |
| E | = | Total RMS electric field strength (V/m) |

NOTE: The primary factors that control rate of energy absorption were found to be the wavelength of the incident field in relations to the dimensions and geometry of the irradiated organism, the orientation of the organism in relation to the polarity of field vectors, the presence of reflecting surfaces, and whether conductive contact is made by the organism with a ground plane.[4]

3.1 SAR MEASUREMENT SET-UP

These measurements are performed using the DASY3 automated dosimetric assessment system. It is made by Schmid & Partner Engineering AG (SPEAG) in Zurich, Switzerland. It consists of high precision robotics system (Staubli), robot controller, Pentium III computer, near-field probe, probe alignment sensor, and the generic twin phantom containing the brain equivalent material. The robot is a six-axis industrial robot performing precise movements to position the probe to the location (points) of maximum electromagnetic field (EMF) (see Fig. 2).

A cell controller system contains the power supply, robot controller, teach pendant (Joystick), and remote control, is used to drive the robot motors. The PC consists of the Micron Pentium III 500 MHz computer with Windows NT system and SAR Measurement Software DASY3, A/D interface card, monitor, mouse, and keyboard. The Staubli Robot is connected to the cell controller to allow software manipulation of the robot. A data acquisition electronic (DAE) circuit performs the signal amplification, signal multiplexing, AD-conversion, offset measurements, mechanical surface detection, collision detection, etc. is connected to the Electro-optical coupler (EOC). The EOC performs the conversion from the optical into digital electric signal of the DAE and transfers data to the PC plug-in card.

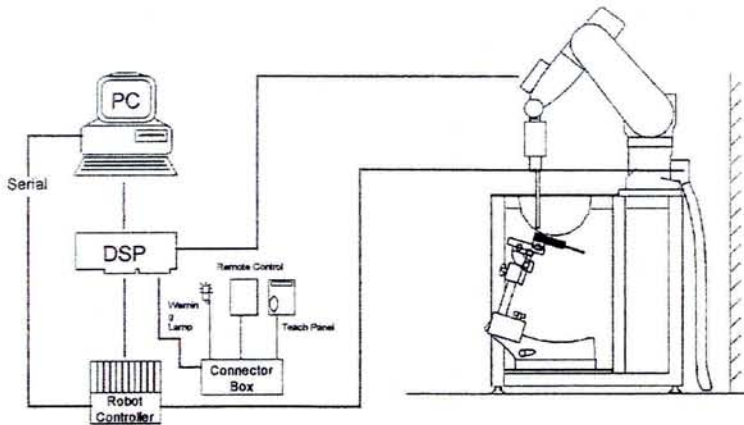

Figure 3. PCTEST SAR Lab II Test Measurement Set-up

The DAE3 consists of a highly sensitive electrometer-grade preamplifier with auto-zeroing, a channel and gain-switching multiplexer, a fast 16 bit AD-converter and a command decoder and control logic unit. Transmission to the PC-card is accomplished through an optical downlink for data and status information and an optical uplink for commands and clock lines. The mechanical probe mounting device includes two different sensor systems for frontal and sidewise probe contacts. They are also used for mechanical surface detection and probe collision detection. The robot uses its own controller with a built in VME-bus computer. The system is described in detail in [5].

4.1 DASYS3 E-FIELD PROBE SYSTEM

4.2 ET3DV5 Probe Specification

| | |
|-------------------|---|
| Construction | Symmetrical design with triangular core Built-in optical fiber for surface detection System Built-in shielding against static charges |
| Calibration | In air from 10 MHz to 2.5 GHz In brain and muscle simulating tissue at Frequencies of 450 MHz, 900 MHz and 1.8 GHz (accuracy $\pm 8\%$) |
| Frequency | 10 MHz to > 6 GHz; Linearity: ± 0.2 dB (30 MHz to 3 GHz) |
| Directivity | ± 0.2 dB in brain tissue (rotation around probe axis) ± 0.4 dB in brain tissue (rotation normal probe axis) |
| Dynamic Range | 5 μ W/g to > 100 mW/g; Linearity: ± 0.2 dB |
| Surface Detection | ± 0.2 mm repeatability in air and clear liquids over diffuse reflecting surfaces. |
| Dimensions | Overall length: 330 mm Tip length: 16 mm Body diameter: 12 mm Tip diameter: 6.8 mm Distance from probe tip to dipole centers: 2.7 mm |
| Application | General dosimetry up to 3 GHz Compliance tests of mobile phones Fast automatic scanning in arbitrary phantoms |

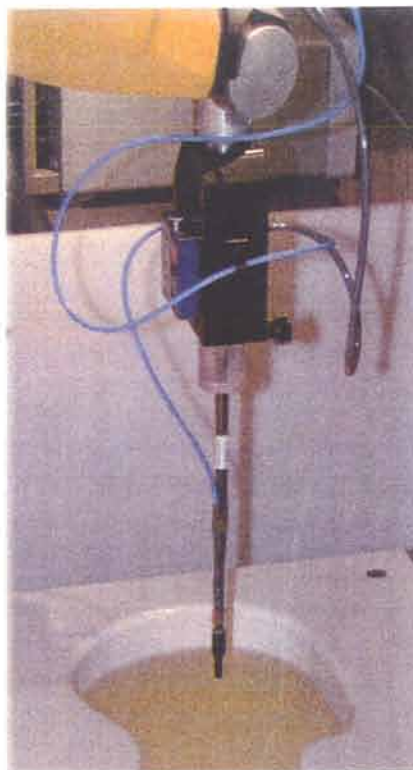

Figure 4. Photograph of the Probe and the Phantom



Fig. 5. ET3DV5 E-field Probe

The SAR measurements were conducted with the dosimetric probe ET3DV5, designed in the classical triangular configuration [5] and optimized for dosimetric evaluation. The probe is constructed using the thick film technique; with printed resistive lines on ceramic substrates. The probe is equipped with an optical multifiber line ending at the front of the probe tip. It is connected to the EOC box on the robot arm and provides an automatic detection of the phantom surface. Half of the fibers are connected to a pulsed infrared transmitter, the other half to a synchronized receiver. As the probe approaches the surface, the reflection from the surface produces a coupling from the transmitting to the receiving fibers. This reflection increases first during the approach, reaches a maximum and then decreases. If the probe is flatly touching the surface, the coupling is zero. The distance of the coupling maximum to the surface is independent of the surface reflectivity and largely independent of the surface to probe angle. The DASYS3 software reads the reflection during a software approach and looks for the maximum using a 2nd order fitting. The approach is stopped at reaching the maximum.

5.1 E-FIELD PROBE CALIBRATION PROCESS

5.2 E-Probe Calibration

Each probe is calibrated according to a dosimetric assessment procedure described in [6] with an accuracy better than +/- 10%. The spherical isotropy was evaluated with the procedure described in [7] and found to be better than +/-0.25dB. The sensitivity parameters (NormX, NormY, NormZ), the diode compression parameter (DCP) and the conversion factor (ConvF) of the probe is tested.

The free space E-field from amplified probe outputs is determined in a test chamber. This is performed in a TEM cell for frequencies below 1 GHz, and in a waveguide above 1 GHz for free space. For the free space calibration, the probe is placed in the volumetric center of the cavity and at the proper orientation with the field. The probe is then rotated 360 degrees.

E-field temperature correlation calibration is performed in a flat phantom filled with the appropriate simulated brain tissue. The measured free space E-field in the medium correlates to temperature rise in a dielectric medium. For temperature correlation calibration a RF transparent thermistor-based temperature probe is used in conjunction with the E-field probe.

$$SAR = C \frac{\Delta T}{\Delta t}$$

where:

- Δt = exposure time (30 seconds),
- C = heat capacity of tissue (brain or muscle),
- ΔT = temperature increase due to RF exposure.

SAR is proportional to $\Delta T / \Delta t$, the initial rate of tissue heating, before thermal diffusion takes place. Now it's possible to quantify the electric field in the simulated tissue by equating the thermally derived SAR to the E- field;

$$SAR = \frac{|E|^2 \cdot \sigma}{\rho}$$

where:

- σ = simulated tissue conductivity,
- ρ = Tissue density (1.25 g/cm³ for brain tissue)

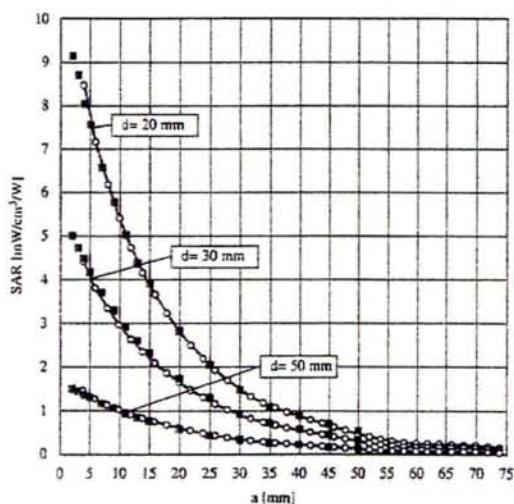

Figure 6. E-Field and Temperature measurements at 900MHz [5]

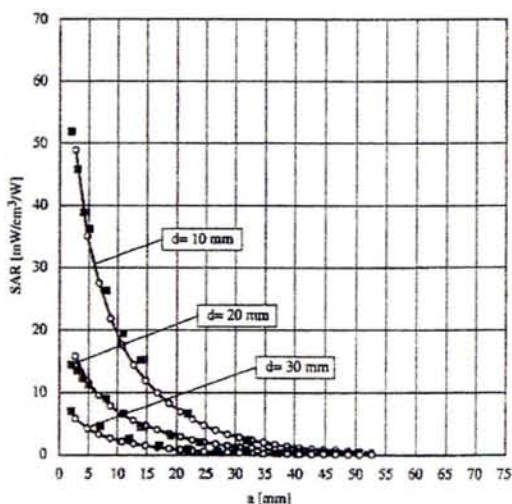

Figure 7. E-Field and temperature measurements at 1.8GHz [5]

8.1 MEASUREMENT PROCESS

8.2 System Verification

Prior to assessment, the system is verified to the $\pm 5\%$ of the specifications at 835MHz by using the system validation kit. (Graphic Plots Attached)

| Validation Kit | Brain | Targeted SAR _{1g} (mW/g) | Measured SAR _{1g} (mW/g) |
|------------------|-------|-----------------------------------|-----------------------------------|
| D835V2, S/N: 406 | | 2.11 | 2.17 |

8.3 Dosimetric Assessment Setup

The evaluation was performed with the following procedure:

1. The SAR value at a fixed location above the ear point was measured and was used as a reference value for assessing the power drop.
2. The SAR distribution at the exposed side of the head was measured at a distance of 3.9mm from the inner surface of the shell. The area covered the entire dimension of the head and the horizontal grid spacing was 20mm x 20mm. Based on this data, the area of the maximum absorption was determined by spline interpolation.
3. Around this point, a volume of 32mm x 32mm x 34mm was assessed by measuring 5 x 5 x 7 points. On this basis of this data set, the spatial peak SAR value was evaluated with the following procedure:
 - a. The data at the surface were extrapolated, since the center of the dipoles is 2.7mm away from the tip of the probe and the distance between the surface and the lowest measuring point is 1.2mm. The extrapolation was based on a least square algorithm [13]. A polynomial of the fourth order was calculated through the points in z-axis. This polynomial was then used to evaluate the points between the surface and the probe tip.
 - b. The maximum interpolated value was searched with a straight-forward algorithm. Around this maximum the SAR values averaged over the spatial volumes (1g or 10g) were computed using the 3D-Spline interpolation algorithm. The 3D-spline is composed of three one-dimensional splines with the "Not a knot" condition (in x,y, and z directions) [13][14]. The volume was integrated with the trapezoidal algorithm. One thousand points (10 x 10 x 10) were interpolated to calculate the average.
 - c. All neighboring volumes were evaluated until no neighboring volume with a higher average value was found.
4. The SAR value, at the same location as procedure #1, was re-measured. If the value changed by more than 5%, the evaluation is repeated.

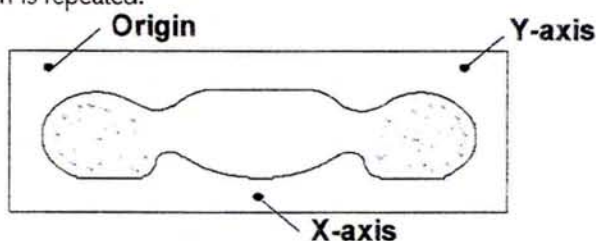

Fig 10. SAR Measurement Points in Area Scan

9.1 TEST POSITION OF THE PHONE

9.2 HANDSET TEST POSITION

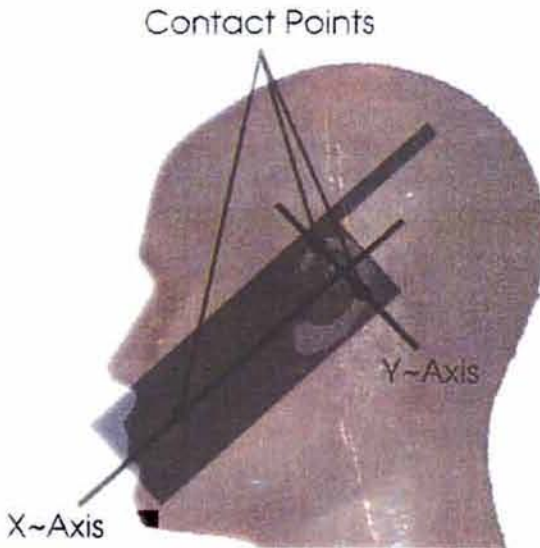

Figure 11. Diagram showing Typical Alignment & Contact Points

The device was placed in a normal operating position with the center of its ear-piece aligned with the location of the ear canal on the phantom (See Fig. 11). With the ear-piece pressed against the head, the vertical center line of the body of the handset was aligned with an imaginary plane consisting of the three lines joining both ears and the tip of the mouth. While maintaining these alignments, the body of the handset was gradually moved towards the cheek until any point on the mouth-piece or keypad contacted the cheek [15]. An upper right-hand corner antenna requires the left-hand phantom while handsets with an upper left antenna requires the right-hand phantom. The handset was tested both with its antenna extended (out) and retracted (in). A sample diagram of a typical handset shows the earpiece at the center of the X and Y axis, placed at the center of the ear canal of the phantom (see Fig. 12 and 13).



Fig 12. Sample of Handset Alignment with the Ear Canal of the Phantom

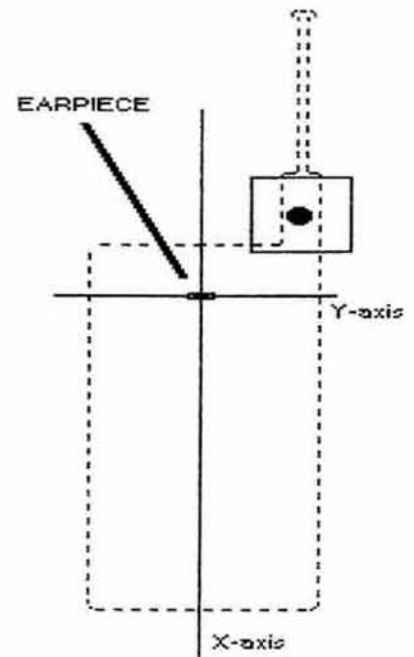

Figure 13. Origin of Axis at Earpiece Position

Test Date(s): November 27, 2000

13.1 SAR TEST DATA SUMMARY

| | |
|----------------------------|------|
| Ambient TEMPERATURE (°C) | 21.4 |
| Relative HUMIDITY (%) | 57.8 |
| Atmospheric PRESSURE (kPa) | 99.6 |

| | |
|----------------------|--------------|
| Mixture Type: | 835MHz Brain |
| Dielectric Constant: | 42.5 |
| Conductivity: | 0.86 |

Closest Distance (between E-Probe & Phone Antenna): 1.9 cm

13.2 Measurement Results (Full Scan AMPS Head SAR)

| FREQUENCY | | Modulation | POWER (dBm) | Phantom Position | | Antenna Position | SAR (W/kg) |
|--|------|------------|----------------|--|---------------|---------------------|---------------|
| MHz | Ch. | | | | | | |
| 836.49 | 0383 | AMPS | 26.5 | Left Ear | w/o absorber | In | 1.260 |
| 836.49 | 0383 | AMPS | 26.5 | Left Ear | w/o absorber | Out | 0.699 |
| 836.49 | 0383 | AMPS | 26.5 | Left Ear | with absorber | In | 1.250 |
| 836.49 | 0383 | AMPS | 26.5 | Left Ear | with absorber | Out | 0.620 |
| ANSI / IEEE C95.1 1992 - SAFETY LIMIT | | | | Brain 1.6 W/kg (mW/g) averaged over 1 gram | | | |
| Spatial Peak Uncontrolled Exposure/General Population | | | | | | | |

NOTES:

- The test data reported are the worst-case SAR value with the antenna-head position set in a typical configuration.
- Cell Shield is tested with typical Cellular AMPS Mode Phone.
- Battery Type Standard Extended
Radiated measurements indicate that the extended-life battery produces a lower ERP, therefore the standard-life battery is used.
- *Power Measured Conducted EIRP ERP
- SAR Measurement System SPEAG IDX
- SAR Configuration Head Body Hand



Randy Ortanez
President & Chief Engineer



Figure 17. Head SAR Test Setup
With Cell Shield Absorber

CELL SHIELD Electromagnetic Field Absorber -- FM Head SAR

Generic Twin Phantom; Left Hand Section; Probe: ET3DV5 - SN1370 -- Probe Cal Date 02/00
Med. Parameters 835 MHz Brain: $\sigma = 0.86$ mho/m $\epsilon_r = 42.5$ $\rho = 1.00$ g/cm³; Antenna Position -- In; Crest Factor 1.0
SAR (1g): 1.26 mW/g, SAR (10g): 0.873 mW/g

Cell Shield Electromagnetic Field Absorber
FM Mode, Ch.0383 [836.49MHz]
Conducted Power = 26.5dBm; w/o cell shield absorbers
Test Date -- 11/27/2000

